



eldes

ESIM110
ESIM120

GSM SWITCH-GATE CONTROLLER

SAFETY INSTRUCTIONS

Please read and follow these safety guidelines to safeguard yourself and others:

- GSM switch-gate controller ESIM110/ESIM120 (later referred to as “the system” or “the device”) contains a built-in radio transceiver operating in GSM 850/900/1800/1900 MHz bands.
- DO NOT use the system where it can cause potential danger and interfere with other devices - such as medical devices.
- DO NOT use the system in hazardous environment.
- DO NOT expose the system to high humidity, chemical environment or mechanical impact.
- DO NOT attempt to repair the system yourself - any repairs must be carried out by fully qualified personnel only.



Disconnect the mains power before installing. Never install or carry out maintenance during stormy weather. The electric socket that powers the system must be easily accessible.



Please use the 10-24V 50Hz ~200mA AC or 10-24V --- 200mA DC power supply unit that meets the EN 60950-1 standard. Any additional device you connect to the system, such as a computer, must also be powered by an EN 60950-1 approved supply. When connecting the power supply to the system, switching the polarity terminal places does not have any affect.



External power supply can be connected to AC mains only inside installation room with automatic 2-pole circuit breaker capable of disconnecting circuit in the event of short circuit or over-current condition. Open circuit breaker must have a gap between connections of more than 3mm and the disconnection current 5A.

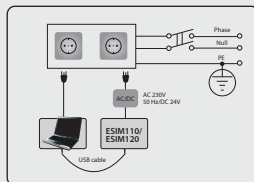

To switch the system off, unplug the external electric power supply from or any other linked device that the system is powered from



A blown fuse cannot be replaced by the user. The replacement fuse has to be of the kind indicated by the manufacturer (fuse F1 model - MINISMDC050F 0.5A).



If you use a computer for the device configuration, it must be earthed.



The WEEE (Waste Electrical and Electronic Equipment) symbol on this product (see left) means it must not be disposed of in household waste. To prevent possible harm to human health and/or the environment, you must dispose of this product in an approved and environmentally safe recycling facility. For further information contact your system supplier, or your local waste authority.

CONTENTS

1. GENERAL INFORMATION	6
2. TECHNICAL SPECIFICATIONS	6
2.1. Electrical & Mechanical Characteristics	6
2.2. Main Unit, LED Indicator & Connector Functionality	7
2.3. Wiring Diagrams	8
3. INSTALLATION	9
4. GENERAL OPERATION	10
5. CONFIGURATION METHODS	10
5.1. SMS Text Messages	10
5.2. ELDES Configuration Tool	10
5.3. Remote Configuration via Web Browser	10
6. SYSTEM LANGUAGE	14
7. SMS PASSWORD	15
8. ADMINISTRATOR PHONE NUMBERS	15
9. DATE AND TIME	17
9.1. Automatic Date and Time Synchronization	17
10. USER PHONE NUMBER DATABASE	19
10.1. User Validity and Access Restriction	21
11. OUTPUT (-S)	24
11.1. Output Name (-s)	24
11.2. Output Control by Free of Charge Phone Call	25
11.3. Output Control by SMS Text Message	26
11.4. Output Control Confirmation by Call Back	29
11.5. Output Control from any Phone Number	30
11.6. Automatic Output Control	30
12. SCHEDULERS	32
13. EVENT LOG	34
14. INPUTS	36
14.1. Input Names and Alarm Notifications	36
14.2. Disabling and Enabling Inputs	38
15. SYSTEM INFORMATION. INFO SMS	39
15.1. Periodic Info SMS	39
16. SYSTEM NOTIFICATIONS	40
16.1. SMSC (Short Message Service Center) Phone Number	40
17. GPRS NETWORK SETTINGS	41
18. REMOTE SYSTEM RESTART	42
19. TECHNICAL SUPPORT	43
19.1. Troubleshooting	43
19.2. Restoring Default Parameters	43
19.3. Updating the Firmware via USB Cable	43
20. RELATED PRODUCTS	44

Limited Liability

The buyer agrees that the system will reduce the risk of fire, theft, burglary or other danger but that it does not guarantee against the occurrence of such events. "ELDES UAB" will not take any responsibility for the loss of personal effects, property or revenue whilst using the system. The liability of "ELDES UAB" is limited to the value of the system purchased. "ELDES UAB" is not affiliated with any mobile/wireless/cellular provider and is therefore not responsible for the quality of such services.

Manufacturer Warranty

The system carries a 24-month manufacturer warranty from "ELDES UAB". The warranty begins the day the system is purchased by the user and the receipt must be retained as proof of purchase date. The warranty remains valid only if the system is used as intended, following all guidelines outlined in this manual and in accordance with the operating conditions specified. The warranty is void if the system has been exposed to mechanical impact, chemicals, high humidity, fluids, corrosive and hazardous environments or force majeure factors.

Dear Customer,

Thank you for choosing to purchase the GSM switch-gate controller ESIM110/ESIM120. Your thoughtful decision will ensure reliable solution for many years as all ELDES products are manufactured to meet the highest standards.

We are confident that you will be completely satisfied with your product. However, in the unlikely event that you do experience a problem, please contact the dealer from whom you made your purchase.

UAB ELDES
www.eldes.it

Contents of Pack

Item	Quantity
1. ESIM110/ESIM120	1
2. User manual	1
3. GSM antenna.	1

Copyright © "ELDES UAB", 2013. All rights reserved

It is strictly forbidden to copy and distribute information in this document or pass to a third party without an advanced written authorization from "ELDES UAB". "ELDES UAB" reserves the right to update or modify this document and/or related products without a warning. Hereby, "ELDES UAB" declares that the GSM switch-gate controller ESIM110/ESIM120 is in compliance with the essential requirements and other relevant provisions of Directive 1999/5/EC. The declaration of conformity may be consulted at www.eldes.it.



1. GENERAL INFORMATION

ESIM110/ESIM120 is a micro-controller based device intended to provide access control for gate automatics, road barriers or to remotely turn ON/OFF any electrical appliance via the GSM network.

Examples of using the system:

- Access control.
- Parking lot control of residential houses or offices.
- Gate control of private houses.
- Any electrical appliance control: lighting, watering, heating etc.
- Remote reboot of the “frozen” systems, such as computer network or a server.

Main features

- Manual output control by free of charge phone call.
- Automatic output control in accordance with the scheduled time.
- Configurable output pulse duration.
- Automatic date and time synchronization.
- Up to 5 administrators for system configuration by SMS text messages, acceptance of input alarm SMS text messages, output control by SMS text message and free of charge phone call.
- User database capacity - up to 500 (1000 - optional) users for output control by free of charge phone call.
- User phone number validity limitation in accordance with a set deadline (date/time) or number of rings to the system.
- Output control restriction for users in accordance with the specified weekdays and time.
- Event log of 1000 events containing date and time as well as administrator/user phone number and user name who controlled the output.
- 3 inputs with customizable alarm texts for notification on gate state or in case it gets jammed.
- Periodic self-test notification by SMS text message to administrator phone number.

2. TECHNICAL SPECIFICATIONS

2.1. Electrical & Mechanical Characteristics

Supply voltage	10-24V 50Hz ~ 200mA max / 10-24V $\overline{\text{---}}$ 200mA max
Current used in standby mode	up to 50mA
GSM modem frequency	850/900/1800/1900 MHz
Number of outputs	1 (ESIM110); 2 (ESIM120)
Output type	Relay; NO (normally-open)
Maximum commuting output values	24V 50Hz ~ 0,5A / 24V $\overline{\text{---}}$ 1A
Number of “low” level (negative) inputs	2
Number of “high” level (positive) inputs	1
“Low” level (negative) input value range	0... 16V $\overline{\text{---}}$ -0.8... -0.4mA
“High” level (positive) input value range	5... 50V $\overline{\text{---}}$ 0.17 ... 1.7mA
“Low” level (negative) and “high” level (positive) input connection type	NO (normally-open)
Dimensions	70x85x57mm
Operating temperature range	-20...+55°C (-30...+55°C with limitations)
Humidity	0-90% RH @ 0... +40 °C (non-condensing)

2.2. Main Unit, LED Indicator & Connector Functionality

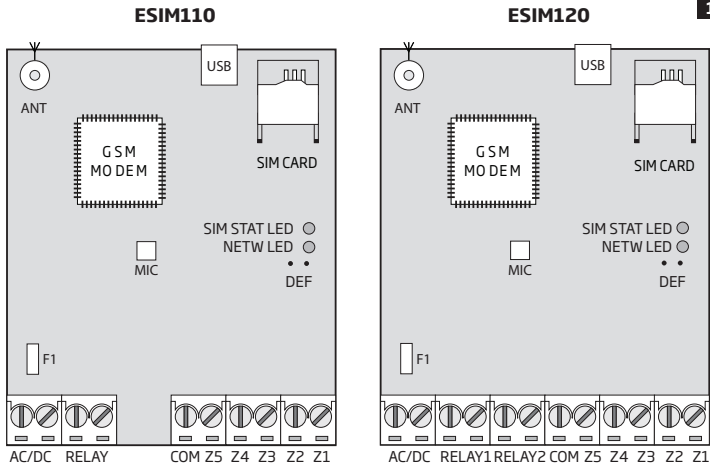

Main Unit Functionality

ANT	GSM antenna SMA type connector
USB	Mini USB port
SIM CARD	SIM card slot / holder
GSM MODEM	GSM network 850/900/1800/1900 MHz modem
MIC	N/A
SIM STAT	Red light-emitting diode indicating SIM card status
NETW	Green light-emitting diode indicating GSM signal strength
DEF	Pins for restoring default settings
F1	0.5A fuse

Connector Functionality

AC/DC	Power supply terminals
RELAY	ESIM110 output C1 terminal
RELAY1	ESIM120 output C1 terminal
RELAY2	ESIM120 output C2 terminal
COM	Common terminal
Z5	N/A
Z4	N/A
Z3	"Low" level (negative) input terminal
Z2	"High" level (positive) input terminal
Z1	"Low" level (negative) input terminal

LED Indicator Functionality

SIM STAT indication	SIM card status
Steady ON	SIM card is not yet connected to the GSM network / SIM card is not present / PIN code enabled
OFF	SIM card is operating successfully (if NETW LED is steady ON or flashing)

NETW indication	GSM signal strength
OFF	No GSM signal
Flashing every 1 sec.	Poor
Flashing several times per sec.	Medium
Steady ON	Excellent

2.3. Wiring Diagrams

General wiring

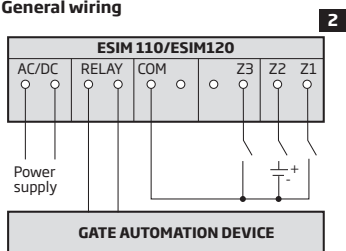

Example of ESIM120 system wiring to gate automation device

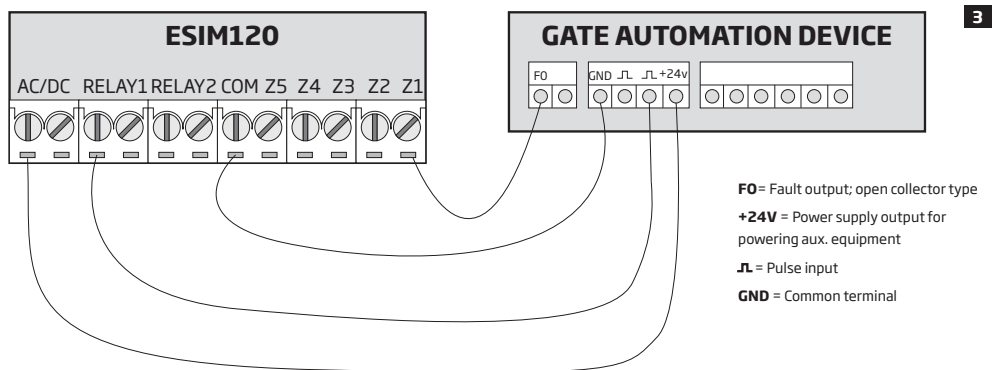

3. INSTALLATION

- The system should be installed indoors, in stationary environment ONLY.
- For the connection of input/output terminals, use 0.50 mm² 1 thread unshielded cable of up to 100 meters length.

1. Wire up the system in accordance with the wiring diagrams (see **2.3 Wiring Diagrams** for more details).
2. Connect the GSM antenna. Based on the type of the GSM antenna supplied with ESIM110/ESIM120 unit, follow the recommendations for the antenna installation:

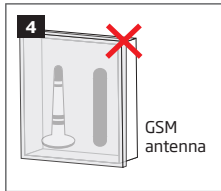

Never install in the following locations:

- inside the metal cabinet
- closer than 20 cm from the metal surface and/or power lines

3. Disable the PIN code request of the SIM card by inserting it into a mobile phone and following the proper menu steps.
4. Once the PIN code is disabled, insert the SIM card into the SIM card slot / holder of ESIM110/ESIM120 system.

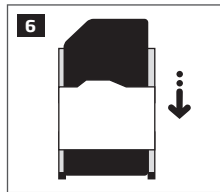
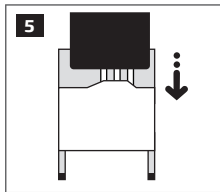

5. Power up the system and wait until indicator SIM STAT lights up indicating SIM card status.
6. Once the indicator SIM STAT lights OFF, the illuminated indicator NETW lights up indicating that the system has successfully connected to the GSM network. To find the strongest GSM signal, position the GSM antenna and follow the indications provided by NETW indicator (see **2.2. Main Unit, LED Indicator & Connector Functionality** for more details).
7. Change the system language if necessary (see **6. SYSTEM LANGUAGE** for more details).
8. Change the default SMS password (see **7. SMS PASSWORD** for more details).
9. Set the phone number for Admin 1 (see **8. ADMINISTRATOR PHONE NUMBERS** for more details).
10. Set system date and time (see **9. DATE AND TIME** for more details).
11. Once the system is fully configured, it is ready for use. However, if you fail to receive a reply by SMS text message from the system, please check the SMSC (Short Message Service Center) phone number. For more details regarding the SMS center phone number, please refer to **17. SMSC (Short Message Service Center) Phone Number**.

ATTENTION: The system is NOT compatible with pure 3G SIM cards. Only 2G/GSM SIM cards and 3G SIM cards with 2G/GSM profile enabled are supported. For more details, please contact your GSM operator.

ATTENTION: We also recommend you to disable **call forwarding, voice mail/text message reports on missed/busy calls** and similar services that might cause incorrect system operation. Please contact your GSM operator for more details on these services and how to disable them.

NOTE: For maximum system reliability we recommend you do NOT use a Pay As You Go SIM card. Otherwise, in the event of insufficient credit balance on the SIM card, the system would fail to make a phone call or send SMS text messages.

NOTE: We advise you to choose the same GSM SIM provider for your system as for your mobile phone. This will ensure the fastest, most reliable SMS text message delivery service and phone call connection.

NOTE: Even though the installation process of ESIM110/ESIM120 is not too complicated, we still recommend to perform it by a person with basic knowledge in electrical engineering and electronics to avoid any system damage.

4. GENERAL OPERATION

When a phone call is made to the phone number of the SIM card inserted in ESIM110/ESIM120, the system will verify if the caller's phone number exists in the memory. If the caller is one of the 5 administrators or the phone number belongs to one of the 500 database users, the system will reject the phone call, thus making the phone call free of charge, and open the gate. By ringing to ESIM110/ESIM120 again, it will close the gate. If the phone number is not recognized, the system will reject the phone call and ignore it. The GSM switch-gate controller can also control your gate automatically in accordance with the scheduled time or by sending an SMS text message from the administrator's phone number.

By connecting a sensor to one of the 3 inputs, the administrators can receive SMS text messages regarding the gates that failed to close during the set time period.

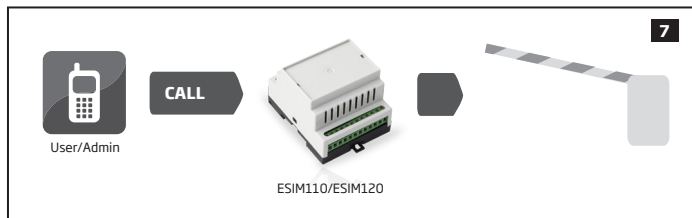

5. CONFIGURATION METHODS

5.1. SMS Text Messages



!!! In this installation manual the underscore character “_” represents one space character. Every underscore character must be replaced by a single space character. There must be no spaces or other unnecessary characters at the beginning and at the end of the SMS text message.



In order to configure and control the system by SMS text message, send the text command to the ESIM110/ESIM120 system phone number from one of the preset administrator phone numbers. The structure of SMS text message consists of 4-digit SMS password (the default SMS password is 0000 - four zeros), the parameter and value. For some parameters the value does not apply e. g. STATUS. The variables are indicated in lower-case letters, while a valid parameter value range is indicated in brackets.

5.2. ELDES Configuration Tool



Software *ELDES Configuration Tool* is intended for ESIM110/ESIM120 GSM switch-gate controller configuration via USB port locally. This software simplifies system configuration process by allowing to use a personal computer in the process. Before starting to use *ELDES Configuration Tool* software, please read the user guide provided in the software's HELP section.

ELDES Configuration Tool is freeware and can be downloaded at: www.eldes.lt/en/download

NOTE: *ELDES Configuration Tool* software is secured with SMS password. The default SMS password is **0000** (see **7. SMS PASSWORD**).

5.3. Remote Configuration via Web Browser



The system comes equipped with a remote configuration feature allowing to configure the parameters via any available web browser. Before remotely connecting to ESIM110/ESIM120 via GPRS connection, ensure that:

- SIM card is inserted into the SIM CARD slot (see **2.2. Main Unit, LED & Connector Functionality**).
- Mobile internet service (GPRS) is enabled on the SIM card.
- ESIM110/ESIM120 is powered up.
- Default SMS password is changed to a new 4-digit password (see **7. SMS PASSWORD**).
- Admin 1 phone number is set up (see **8. ADMINISTRATOR PHONE NUMBERS**).
- APN, user name and password are set up (see **17. GPRS NETWORK SETTINGS**).

The system supports the following remote connection modes:

- **CLIENT** - The device connects to the configuration server making the device accessible through a web browser when the administrator logs in via ELDES website (see **5.3.1. Establishing Remote Connection**). This mode is set by default and DOES NOT require the static IP address for the device SIM card. Default Client mode parameters are as follows:
 - **Server IP** - config.eldes.lt
 - **DNS1** - 84.32.3.34
 - **DNS1** - 84.32.134.1
 - **Port** - 5555
- **SERVER** - The device is accessible directly through a web browser using the device IP address and local port number (see **5.3.1. Establishing Remote Connection**). A static IP address, provided by GSM operator, is required for the device SIM card. This mode is for advanced use only. Default Server mode parameters are as follows:
 - **Local Port** - 5000
 - **Protocol** - TCP

Set remote connection mode as Server

SMS

SMS text message content:

`ssss_SETGPRS:TYPE:SERVER`

Value: ssss - 4-digit new SMS password.

Example: 1111_SETGPRS:TYPE:SERVER

Config Tool

This operation may be carried out from the PC using the *ELDES Configuration Tool* software.

WEB BROWSER

This operation may be remotely carried out from the PC using the web browser.

Set local port

SMS

SMS text message content:

`ssss_SETGPRS:LPORT:lpport`

Value: ssss - 4-digit new SMS password; lpport - local port number, range - [1... 65535].

Example: 1111_SETGPRS:LPORT:5000

Config Tool

This operation may be carried out from the PC using the *ELDES Configuration Tool* software.

WEB BROWSER

This operation may be remotely carried out from the PC using the web browser.

Set protocol

SMS

SMS text message content:

`sssss_SETGPRS:PROTOCOL:ptc`

Value: ssss - 4-digit SMS password; ptc - protocol, range - [TCP... UDP].

Example: 1111_SETGPRS:PROTOCOL:UDP

Config Tool

This operation may be carried out from the PC using the *ELDES Configuration Tool* software.

WEB BROWSER

This operation may be remotely carried out from the PC using the web browser.

Set remote connection mode as Client

SMS

SMS text message content:

`ssss_SETGPRS:TYPE:CLIENT`

Value: ssss - 4-digit new SMS password.

Example: 1111_SETGPRS:TYPE:CLIENT

Config Tool

This operation may be carried out from the PC using the *ELDES Configuration Tool* software.

WEB BROWSER

This operation may be remotely carried out from the PC using the web browser.

Set server IP address

SMS

SMS text message content:

`ssss_SETGPRS:IP:addr.addr.addr.addr`

Value: ssss - 4-digit SMS password; *addr.addr.addr.addr* - server IP address.

Example: 1111_SETGPRS:IP:65.02.119.5

Config Tool

This operation may be carried out from the PC using the *ELDES Configuration Tool* software.

WEB BROWSER

This operation may be remotely carried out from the PC using the web browser.

Set server port

SMS

SMS text message content:

`ssss_SETGPRS:PORT:pprrt`

Value: ssss - 4-digit SMS password; *pprrt* - server port number, range - [1... 65535].

Example: 1111_SETGPRS:PORT:5521

Config Tool

This operation may be carried out from the PC using the *ELDES Configuration Tool* software.

WEB BROWSER

This operation may be remotely carried out from the PC using the web browser.

Set DNS1 server IP address

Config Tool

This operation may be carried out from the PC using the *ELDES Configuration Tool* software.

WEB BROWSER

This operation may be remotely carried out from the PC using the web browser.

Set DNS2 server IP address

Config Tool

This operation may be carried out from the PC using the *ELDES Configuration Tool* software.

WEB BROWSER

This operation may be remotely carried out from the PC using the web browser.

View remote configuration parameters

SMS

SMS text message content:

`ssss_SETGPRS?`

Value: ssss - 4-digit SMS password.

Example: 1111_SETGPRS?

Config Tool

This operation may be carried out from the PC using the *ELDES Configuration Tool* software.

WEB BROWSER

This operation may be remotely carried out from the PC using the web browser.

5.3.1. Establishing Remote Connection

1. In order to activate a remote connection, please send the following SMS text message from user phone number. Upon the successful SMS text message delivery, the system establishes a connection session for 20 minutes. An SMS reply, containing temporal user name and password, will be sent shortly.

Establish remote connection

SMS

SMS text message content:

`ssss_CONNECT:PROFILE1`

Value: ssss - 4-digit new SMS password.

Example: 1111_CONNECT:PROFILE1

To set a different session duration or connect for a custom session duration, please refer to the following configuration methods.

Set session duration

Config Tool

This operation may be carried out from the PC using the *ELDES Configuration Tool* software.

WEB BROWSER

This operation may be remotely carried out from the PC using the web browser.

Establish remote connection for custom session duration

SMS

SMS text message content:

`ssss_CONNECT:TIMEOUT:ses-d`

Value: ssss - 4-digit new SMS password; ses-d - session duration, range - [0.. 14400] minutes.

Example: 1111_CONNECT:TIMEOUT:120

Alternatively, the system supports remote connection establishment by making a phone call from the administrator phone number to the system. Once the call is received, the system rejects the call thus making it free of charge and replies with the login details by SMS text message to the administrator phone number. By default, this feature is disabled. To enable/disable it, please refer to the following configuration methods.

Enable/disable remote connection establishment by phone call

Config Tool

This operation may be carried out from the PC using the *ELDES Configuration Tool* software.

WEB BROWSER

This operation may be remotely carried out from the PC using the web browser.

NOTE: 0 value sets unlimited session duration.

NOTE: *ELDES Configuration Tool* software and remote configuration web interface allows to set the unlimited session duration value.

NOTE: Once the remote connection establishment by phone call is enabled, the specified administrator will no longer be able to control the output via free of charge phone call.

2. a) If running in Client mode, open a web browser and type in `http://www.eldes.lt/login`.
- b) If running in Server mode, open a web browser and type in `http://deviceIPaddress:localport`

WEB Configuration System WEC2010.

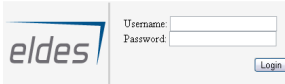

3. Enter the received login details and press *Login* button.
4. After the system configuration is complete, use one of the following methods to end the configuration process:
 - Wait for the session timeout and the system to reply with an SMS text message confirming the end of the session.
 - Shut down the connection with the configuration server at any time by sending an SMS text message.

Shut down the connection with configuration server

SMS

SMS text message content:

Value: `ssss_STOP`

Value: `ssss` - 4-digit new SMS password.

Example: `1111_STOP`

ATTENTION: Output control is disabled during the remote configuration process.

6. SYSTEM LANGUAGE

The system comes equipped with a multiple languages for communication with the administrator by SMS text messages. The default system language depends on the firmware, which is based on the customer's location.

List of currently available system languages:

- English
- Estonian
- German
- Lithuanian
- French
- Slovak

Set system language

SMS

SMS text message content:

Value: `LN`

Value: `LN` - language index; range - [`EN` - English, `EE` - Estonian, `DE` - German, `LT` - Lithuanian, `FR` - French, `SK` - Slovak].

Example: `LT`

Config Tool

This operation may be carried out from the PC using the *ELDES Configuration Tool* software.

WEB BROWSER

This operation may be remotely carried out from the PC using the web browser.

NOTE: To change the language once the system has already been configured, you need to reset the device to the default configuration. For more details on how to do this, please refer to **19.2. Restoring Default Parameters**.

7. SMS PASSWORD

For security reasons, the system uses the following type of password:

- **SMS password** - 4-digit password used for system configuration and control from administrator phone number by SMS text messages and logging in to *ELDES Configuration Tool* software. By default, SMS password is **0000**, which **MUST** be changed!

Set SMS password

SMS

SMS text message content:

`wwwwww_PSW_ssss`

Value: `wwwwww` - 4-digit default SMS password; `sssss` - 4-digit new SMS password; range - [0001... 9999].

Example: `0000_PSW_1111`

Config Tool

This operation may be carried out from the PC using the *ELDES Configuration Tool* software.

WEB BROWSER

This operation may be remotely carried out from the PC using the web browser.

NOTE: The system rejects the SMS text messages containing wrong SMS password even from a preset administrator phone number.

8. ADMINISTRATOR PHONE NUMBERS

The system supports up to 5 administrator phone numbers identified as Admin 1 through 5. When the phone number is set, the administrator will be able to configure and control the system by SMS text messages as well as by free of charge phone call and receive the input alarm SMS text messages from the system (see **14.1. Input Names and Alarm Notification**). ESIM120 allows to assign output C1, output C2 or both outputs (simultaneous control) to a certain administrator.

By default, the system ignores any incoming calls and SMS text messages from a non-preset phone number as well as it rejects the SMS text messages containing wrong SMS password even from a preset administrator phone number. For more details on how to enable output control from a non-preset phone number, please refer to **11.5. Output Control from any Phone Number**.

To set Admin 1 phone number is mandatory, while the other 4 are optional. The supported phone number format is the following:

- **International (w/o plus)** - The phone numbers must be entered starting with an international country code in the following format: [international code][area code][local number], example for UK: 4417091111111.

Set administrator phone number

SMS

SMS text message content:

`sssss_NRas:ttteeellnnumm`

Value: `sssss` - 4-digit SMS password; `as` - administrator phone number slot, range - [1... 5]; `ttteeellnnumm` - up to 15 digits administrator phone number.

Example: `1111_NR1:4417091111111`

Config Tool

This operation may be carried out from the PC using the *ELDES Configuration Tool* software.

WEB BROWSER

This operation may be remotely carried out from the PC using the web browser.

View administrator phone numbers

SMS

SMS text message content:

`sssss_HELPNR`

Value: `sssss` - 4-digit SMS password.

Example: `1111_HELPNR`

Config Tool

This operation may be carried out from the PC using the *ELDES Configuration Tool* software.

WEB BROWSER

This operation may be remotely carried out from the PC using the web browser.

Assign output (-s) to individual administrator

ONLY FOR ESIM120

Config Tool

This operation may be carried out from the PC using the *ELDES Configuration Tool* software.

WEB BROWSER

This operation may be remotely carried out from the PC using the web browser.

Delete administrator phone number

SMS

SMS text message content:

`ssss_NRa:DEL`

Value: ssss - 4-digit SMS password; as - administrator phone number slot, range - [2... 5].

Example: `1111_NR2:DEL`

Config Tool

This operation may be carried out from the PC using the *ELDES Configuration Tool* software.

WEB BROWSER

This operation may be remotely carried out from the PC using the web browser.

ATTENTION: NEVER set a phone number of the device's SIM card as an administrator phone number!

ATTENTION: Once Admin 1 phone number is set, the system will restrict only to modify it

ATTENTION: Multiple administrator phone numbers can be set by a single SMS text message, **Example:** `1111_NR1:4417091111111_NR5:4417091111112_NR2:4417091111113_NR3:4417091111114`

NOTE: Multiple administrator phone numbers can be deleted by a single SMS text message, **Example:** `1111_NR2:DEL_NR4:DEL_NR3:DEL`

NOTE FOR ESIM120: The administrator can control any output by SMS text message regardless of the output assigned to the administrator phone number (see **11.3. Output Control by SMS Text Message**).

For more details on output control, please refer to **11. OUTPUT (-S)**.

9. DATE AND TIME

The system comes equipped with internal real-time clock (RTC) that keeps track of the current date and time. Once the system is up and running, the user must set the correct date and time, otherwise the system will not operate properly. By default, after shutting down and starting up the system, the date and time must be set again. In order to avoid manual date and time set up, please use the automatic date and time synchronization feature (see **9.1. Automatic Date and Time Synchronization**).

Set date and time

SMS

SMS text message content:

`ssss_yyyy.mm.dd_hr:mn`

Value: *ssss* - 4-digit SMS password; *yyyy* - year; *mm* - month, range - [01... 12]; *dd* - day, range - [01... 31]; *hr* - hours, range - [00... 23]; *mn* - minutes, range - [00... 59].

Example: `1111_2013.03.16_14:33`

Config Tool

This operation may be carried out from the PC using the *ELDES Configuration Tool* software.

WEB BROWSER

This operation may be remotely carried out from the PC using the web browser.

9.1. Automatic Date and Time Synchronization

This feature enables the system to set the date and time automatically without the user being involved in this process. The system supports the following methods of automatic date and time synchronization that are used automatically on system start-up and periodically (by default - every 30 days):

- **Via GSM network** - Once enabled, the system automatically sends a date/time request to the GSM operator. This method is the most accurate synchronization method. Some GSM operators might not support it.
- **By SMS text message** - Once enabled, the system automatically sends the SMS text message to its own phone number and retrieves the date and time from the SMS text message reply, as the included date and time is set by the SMSC (SMS center). This method is not as accurate as the synchronization via GSM network, but always effective.

By default, synchronization via GSM network is disabled. To enable/disable automatic date and time synchronization via GSM network, please refer to the following configuration methods.

Enable/disable synchronization via GSM network

Config Tool

This operation may be carried out from the PC using the *ELDES Configuration Tool* software.

WEB BROWSER

This operation may be remotely carried out from the PC using the web browser.

By default, synchronization by SMS text message is disabled. To enable/disable automatic date and time synchronization by SMS text message, please enter/remove device phone number using one of the following configuration methods.

Enter/remove device phone number for synchronization by SMS text message

Config Tool

This operation may be carried out from the PC using the *ELDES Configuration Tool* software.

WEB BROWSER

This operation may be remotely carried out from the PC using the web browser.

By default, the date and time synchronization period is 30 days. To set a different period, please refer to the following configuration methods.

Set synchronization period

Config Tool

This operation may be carried out from the PC using the *ELDES Configuration Tool* software.

WEB BROWSER

This operation may be remotely carried out from the PC using the web browser.

NOTE: When setting up automatic date and time synchronization feature remotely, you may wish to restart the system when done. For more details, please refer to **18. REMOTE SYSTEM RESTART**.

NOTE: 0 value disables periodic date and time synchronization.

NOTE: When both synchronization methods are enabled, the system will always attempt to synchronize date and time via GSM network every time the system shuts down and starts up again and in accordance with the set period value. In the event of first method's failure, the system will attempt to use the SMS text message method as a backup.

10. USER PHONE NUMBER DATABASE

The system comes equipped with a user database of 500 user capacity. When the phone number is set, the user will be able to control the output (-s) by free of charge phone call. ESIM120 user database allows to assign output C1, output C2 or both outputs (simultaneous control) to a certain user. The supported phone number format is the following:

- **International (w/o plus)** - The phone numbers must be entered starting with an international country code in the following format: [international code][area code][local number], example for UK: 4417091111111.

ESIM110/ESIM120 user database supports user validity and access restriction features. For more details, please refer to **10.1. User Validity and Access Restriction**.

Optionally, a user name can be set that typically specifies the owner's name of a certain phone number, for example: *John*.

The phone number and user name (if any) are used when searching for a certain user in the database as well as they are automatically added in the event log after the successful output control event (see **13. EVENT LOG**).

Add user phone number (and user name)

SMS

SMS text message content:

`ssss_N:ttteeellnnumm` or `ssss_N:ttteeellnnumm:user-name`

Value: `ssss` - 4-digit SMS password; `ttteeellnnumm` - up to 15 digits user phone number; `user-name` - up to 16 characters user name.

Example: `1111_N:4417091111111:john`

Config Tool

This operation may be carried out from the PC using the *ELDES Configuration Tool* software.

WEB BROWSER

This operation may be remotely carried out from the PC using the web browser.

View user phone numbers

SMS

SMS text message content:

`ssss_GETALLNUMBERS`

Value: `ssss` - 4-digit SMS password.

Example: `1111_GETALLNUMBERS`

Config Tool

This operation may be carried out from the PC using the *ELDES Configuration Tool* software.

WEB BROWSER

This operation may be remotely carried out from the PC using the web browser.

Search for user by phone number or name

SMS

SMS text message content:

`ssss_T:ttteeellnnumm` or `ssss_T:user-name`

Value: `ssss` - 4-digit SMS password; `ttteeellnnumm` - up to 15 digits user phone number; `user-name` - up to 16 characters user name.

Example: `1111_T:john`

Config Tool

This operation may be carried out from the PC using the *ELDES Configuration Tool* software.

WEB BROWSER

This operation may be remotely carried out from the PC using the web browser.

Assign output (-s) to individual user

ONLY FOR ESIM120

SMS

SMS text message content:

`ssss_OUTPUT_ttteeellnnumm_o` or `ssss_OUTPUT_user-name_o`

Value: `ssss` - 4-digit SMS password; `ttteeellnnumm` - up to 15 digits user phone number; `o` - output number; range [1 - output C1; 2 - output C2; 3 - both outputs]; `user-name` - up to 16 characters user name.

Example: `1111_OUTPUT_441709111111_2`

Config Tool

This operation may be carried out from the PC using the *ELDES Configuration Tool* software.

WEB BROWSER

This operation may be remotely carried out from the PC using the web browser.

Delete individual user

SMS

SMS text message content:

`ssss_D:ttteeellnnumm` or `ssss_D:user-name`

Value: `ssss` - 4-digit SMS password; `ttteeellnnumm` - up to 15 digits user phone number; `user-name` - up to 16 characters user name.

Example: `1111_GETALLNUMBERS`

Config Tool

This operation may be carried out from the PC using the *ELDES Configuration Tool* software.

WEB BROWSER

This operation may be remotely carried out from the PC using the web browser.

Delete all users

SMS

SMS text message content:

`ssss_D:ALL`

Value: `ssss` - 4-digit SMS password.

Example: `1111_D:ALL`

Config Tool

This operation may be carried out from the PC using the *ELDES Configuration Tool* software.

WEB BROWSER

This operation may be remotely carried out from the PC using the web browser.

The user database can be exported/imported to/from a .csv file for backup purposes or for a convenient user database management. To export/import an existing user database, please refer to the following configuration method.

Export/import existing user database from/to file

Config Tool

This operation may be carried out from the PC using the *ELDES Configuration Tool* software.

By default, the user database is enabled and output control by all database users is permitted. To deny output control instead of deleting all users from the database, please disable the user database using one of the following configuration methods.

Disable user database

SMS

SMS text message content:

`ssss_DBM_OFF`

Value: ssss - 4-digit SMS password.

Example: 1111_DBM_OFF

Config
Tool

This operation may be carried out from the PC using the *ELDES Configuration Tool* software.

WEB
BROWSER

This operation may be remotely carried out from the PC using the web browser.

To enable user database, please refer to the following configuration methods.

Enable user database

SMS

SMS text message content:

`ssss_DBM_ON`

Value: ssss - 4-digit SMS password.

Example: 1111_DBM_ON

Config
Tool

This operation may be carried out from the PC using the *ELDES Configuration Tool* software.

WEB
BROWSER

This operation may be remotely carried out from the PC using the web browser.

ATTENTION: Space and colon characters are NOT allowed in the user names.

NOTE: Multiple users can be added by a single SMS text message, **Example:** 1111_N:4417091111111:John_4417091111112:_4417091111113:Tom

NOTE: Multiple users can be deleted by a single SMS text message, **Example:** 1111_D:John_4417091111113_Mark

For more details on output control, please refer to **11. OUTPUT (-S)**.

10.1. User Validity and Access Restriction

The system allows to restrict access in accordance with the scheduler assigned to a certain user. When one or more schedulers are assigned, the user will be able to control the output only on the specified weekdays and time set up in the scheduler. The system allows to assign up to 8 different schedulers. For more details on how to set up the schedulers, please refer to **12. SCHEDULERS**.

In addition, the system allows to limit the user validity by the following methods:

- **Deadline (valid until)** - When a specified date and time hits, the user will be automatically deleted from the database.
- **Ring counter** - When a specified number of phone calls to the system expires, the user will be automatically deleted from the database.

Assign scheduler to individual user

SMS

SMS text message content:

`ssss_NSCHED_ttteeellnuumm_c:ON` or `ssss_NSCHED_user-name_c:ON`

Value: ssss - 4-digit SMS password; `ttteeellnuumm` - up to 15 digits user phone number; `c` - scheduler number; range - [1... 8]; `user-name` - up to 16 characters user name.

Example: 1111_NSCHED_John_5:ON

Config
Tool

This operation may be carried out from the PC using the *ELDES Configuration Tool* software.

WEB
BROWSER

This operation may be remotely carried out from the PC using the web browser.

Remove scheduler from individual user

SMS

SMS text message content:

`ssss_NSCHED_ttteeellnnumm_c:OFF` or `ssss_NSCHED_user-name_c:OFF`

Value: `ssss` - 4-digit SMS password; `ttteeellnnumm` - up to 15 digits user phone number; `c` - scheduler number; range - [1... 8]; `user-name` - up to 16 characters user name.

Example: `1111_NSCHED_John_5:OFF`

Config Tool

This operation may be carried out from the PC using the *ELDES Configuration Tool* software.

WEB BROWSER

This operation may be remotely carried out from the PC using the web browser.

Set deadline for individual user

SMS

SMS text message content:

`ssss_EXPIRYTIME_ttteeellnnumm_yyyy.mm.dd_hr:mn` or `ssss_EXPIRYTIME_user-name_yyyy.mm.dd_hr:mn`

Value: `ssss` - 4-digit SMS password; `ttteeellnnumm` - up to 15 digits user phone number; `yyyy` - year; `mm` - month, range - [01... 12]; `dd` - day, range - [01... 31]; `hr` - hours, range - [00... 23]; `mn` - minutes, range - [00... 59]; `user-name` - up to 16 characters user name.

Example: `1111_EXPIRYTIME_John_2015.06.29_19:35`

Config Tool

This operation may be carried out from the PC using the *ELDES Configuration Tool* software.

WEB BROWSER

This operation may be remotely carried out from the PC using the web browser.

Extend deadline for individual user

SMS

SMS text message content:

`ssss_EXPIRY_ttteeellnnumm_extendmins` or `ssss_EXPIRY_user-name_extendmins`

Value: `ssss` - 4-digit SMS password; `ttteeellnnumm` - up to 15 digits user phone number; `extendmins` - time period, range - [1... 2147483648] minutes; `user-name` - up to 16 characters user name.

Example: `1111_EXPIRY_John_2350`

Config Tool

This operation may be carried out from the PC using the *ELDES Configuration Tool* software.

WEB BROWSER

This operation may be remotely carried out from the PC using the web browser.

View set up deadline for individual user

SMS

SMS text message content:

`ssss_EXPIRYTIME_ttteeellnnumm_?` or `ssss_EXPIRYTIME_user-name_?`

Value: `ssss` - 4-digit SMS password; `ttteeellnnumm` - up to 15 digits user phone number; `user-name` - up to 16 characters user name.

Example: `1111_EXPIRYTIME_441709111111_?`

Config Tool

This operation may be carried out from the PC using the *ELDES Configuration Tool* software.

WEB BROWSER

This operation may be remotely carried out from the PC using the web browser.

Remove deadline from individual user

SMS

SMS text message content:

`ssss_EXPIRYTIME_ttteeeInnuumm_0` or `ssss_EXPIRYTIME_user-name_0`

Value: `ssss` - 4-digit SMS password; `ttteeelInnuumm` - up to 15 digits user phone number; `user-name` - up to 16 characters user name.

Example: `1111_EXPIRYTIME_441709111111_0`

Config Tool

This operation may be carried out from the PC using the *ELDES Configuration Tool* software.

WEB BROWSER

This operation may be remotely carried out from the PC using the web browser.

Set ring counter for individual user

SMS

SMS text message content:

`ssss_RCOUNT_ttteeeInnuumm_numofcalls` or `ssss_RCOUNT_user-name_numofcalls`

Value: `ssss` - 4-digit SMS password; `ttteeelInnuumm` - up to 15 digits administrator phone number; `user-name` - up to 16 characters user name; `numofcalls` - number of phone calls, range - [0... 4294967296].

Example: `1111_RCOUNT_441709111111_152`

Config Tool

This operation may be carried out from the PC using the *ELDES Configuration Tool* software.

WEB BROWSER

This operation may be remotely carried out from the PC using the web browser.

View set up ring counter value for individual user

SMS

SMS text message content:

`ssss_RCOUNT_ttteeeInnuumm_?` or `ssss_RCOUNT_user-name_?`

Value: `ssss` - 4-digit SMS password; `ttteeelInnuumm` - up to 15 digits administrator phone number; `user-name` - up to 16 characters user name.

Example: `1111_RCOUNT_John_?`

Config Tool

This operation may be carried out from the PC using the *ELDES Configuration Tool* software.

WEB BROWSER

This operation may be remotely carried out from the PC using the web browser.

Remove ring counter from individual user

SMS

SMS text message content:

`ssss_RCOUNT_ttteeeInnuumm_0` or `ssss_RCOUNT_user-name_0`

Value: `ssss` - 4-digit SMS password; `ttteeelInnuumm` - up to 15 digits administrator phone number; `user-name` - up to 16 characters user name.

Example: `1111_RCOUNT_John_0`

Config Tool

This operation may be carried out from the PC using the *ELDES Configuration Tool* software.

WEB BROWSER

This operation may be remotely carried out from the PC using the web browser.

ATTENTION: If the date and time are not set, the system will NOT be able to manage user validity and access. For more details on how to set date and time, please refer to **9. DATE AND TIME**.

NOTE: Multiple schedulers can be assigned/removed by a single SMS text message, **Example:** `1111_NSCHED_John_2:ON_6:OFF_3:OFF_5:ON`

NOTE: 0 value removes the set up deadline from the user.

NOTE: 0 value removes the set up ring counter from the user.

11. OUTPUT (-S)

ESIM110 comes equipped with 1 built-in output, while ESIM120 - with 2 outputs. The output (-s) is intended for connection and control of the gate automation device by the following methods:

- Free of charge phone call from the user or administrator phone number (see **11.2. Output Control by Free of Charge Phone Call**).
- SMS text message from the administrator phone number (see **11.3. Output Control by SMS Text Message**).
- Automatically in accordance with the scheduled weekdays and time (see **11.6. Automatic Output Control**).

The system allows to view the current output state by the following configuration method.

View output state

SMS

SMS text message content:

`ssss_STATUS`

Value: ssss - 4-digit SMS password.

Example: `1111_STATUS`

ATTENTION: Once the scheduler, set up for automatic output control, comes into effect, the user/administrator will NOT be able to control the output by phone call and SMS text message (see **11.6. Automatic Output Control**).

11.1. Output Name (-s)

The output (-s) has a name that can be customized. Typically, the name specifies a device type connected to a determined output, for example: *Gate*. The name can be used instead of output number when controlling the output by SMS text message.

By default, the output names are: C1 - *Controll1* (ESIM110, ESIM120), C2 - *Controll2* (ESIM120).

Set output name

ONLY FOR ESIM110

SMS

SMS text message content:

`ssss_C1:out-name`

Value: ssss - 4-digit SMS password; *out-name* - up to 16 characters output name.

Example: `1111_C1:OFF:00.10.15`

Config Tool

This operation may be carried out from the PC using the *ELDES Configuration Tool* software.

WEB BROWSER

This operation may be remotely carried out from the PC using the web browser.

Set output name

ONLY FOR ESIM120

SMS

SMS text message content:

`ssss_Co:out-name`

Value: ssss - 4-digit SMS password; *o* - output number, range [1 - output C1; 2 - output C2]; *out-name* - up to 16 characters output name.

Example: `1111_C1:OFF:00.10.15`

Config Tool

This operation may be carried out from the PC using the *ELDES Configuration Tool* software.

WEB BROWSER

This operation may be remotely carried out from the PC using the web browser.

View output name

SMS

SMS text message content:

`ssss_STATUS`

Value: ssss - 4-digit SMS password.

Example: 1111_STATUS

Config Tool

This operation may be carried out from the PC using the *ELDES Configuration Tool* software.

WEB BROWSER

This operation may be remotely carried out from the PC using the web browser.

ATTENTION: Space, colon, semi-colon characters, parameter names and/or values, such as PSW, STATUS, ON, OFF etc. are NOT allowed in output names.

11.2. Output Control by Free of Charge Phone Call

To open or close the gate, dial the system's phone number from any available user or administrator phone numbers (see **10. USER PHONE NUMBER DATABASE** and **8. ADMINISTRATOR PHONE NUMBERS** for phone number management). The phone call is free charge as the system rejects it and turns ON the output (-s) for the preset time period (pulse; by default - 2 seconds) resulting in the gate opening or closing, depending on the current gate state. If there is more than one preset caller dialing to the system at the same time, the system will accept the incoming call from the caller who was the first to dial while other caller (-s) will be ignored.

The system supports a confirmation phone call to user/administrator phone number. For more details, please refer to **11.4. Output Control Confirmation by Call Back**

Set output pulse duration

SMS

SMS text message content:

`ssss_TIMER1:pl`

Value: ssss - 4-digit SMS password; pl - pulse duration, range - [1... 10] seconds.

Example: 1111_TIMER1:8

Config Tool

This operation may be carried out from the PC using the *ELDES Configuration Tool* software.

WEB BROWSER

This operation may be remotely carried out from the PC using the web browser.

Set output pulse duration

ONLY FOR ESIM120

SMS

SMS text message content:

`ssss_TIMERo:pl`

Value: ssss - 4-digit SMS password; o - output number, range [1 - output C1; 2 - output C2]; pl - pulse duration, range - [1... 10] seconds.

Example: 1111_TIMER2:4

Config Tool

This operation may be carried out from the PC using the *ELDES Configuration Tool* software.

WEB BROWSER

This operation may be remotely carried out from the PC using the web browser.

NOTE: *ELDES Configuration Tool* software and remote configuration web interface allows to set the unlimited output pulse duration value.

11.3. Output Control by SMS Text Message

To open or close the gate, send the SMS text message from any of 5 available administrator phone numbers (see **8. USER PHONE NUMBER DATABASE** for phone number management). The system will turn ON the output (-s) for a determined time period (pulse) resulting in the gate opening or closing, depending on the current gate state. The confirmation reply by SMS text message, containing the output name (see **11.1. Output Name (-s)**), will be sent to the administrator phone number that the output control by SMS text message was initiated from.

Turn ON output
for time period

ONLY FOR ESIM110

SMS

SMS text message content:

`s$$$_C1:ON:hr.mn.sc` or `s$$$_out-name:ON:hr.mn.scv`

Value: `s$$$` - 4-digit SMS password; `hr` - hours, range - [00... 23]; `mn` - minutes, range - [00... 59]; `sc` - seconds, range - [00... 59]; `out-name` - up to 16 characters output name.

Example: `1111_Gate:ON:00.00.02`

Config
Tool

This operation may be carried out from the PC using the *ELDES Configuration Tool* software.

WEB
BROWSER

This operation may be remotely carried out from the PC using the web browser.

Turn OFF output
for time period

ONLY FOR ESIM110

SMS

SMS text message content:

`s$$$_C1:OFF:hr.mn.sc` or `s$$$_out-name:OFF:hr.mn.scv`

Value: `s$$$` - 4-digit SMS password; `hr` - hours, range - [00... 23]; `mn` - minutes, range - [00... 59]; `sc` - seconds, range - [00... 59]; `out-name` - up to 16 characters output name.

Example: `1111_C1:OFF:00.10.15`

Config
Tool

This operation may be carried out from the PC using the *ELDES Configuration Tool* software.

WEB
BROWSER

This operation may be remotely carried out from the PC using the web browser.

To instantly turn ON/OFF the output and set its state to ON/OFF when the system starts-up, please refer to the following configuration methods.

Turn ON output/Set
output start-up state
as ON

ONLY FOR ESIM110

SMS

SMS text message content:

`s$$$_C1:ON` or `s$$$_out-name:ON`

Value: `s$$$` - 4-digit SMS password; `out-name` - up to 16 characters output name.

Example: `1111_C1:ON`

Config
Tool

This operation may be carried out from the PC using the *ELDES Configuration Tool* software.

WEB
BROWSER

This operation may be remotely carried out from the PC using the web browser.

Turn OFF output/Set
output start-up state
as OFF

ONLY FOR ESIM110

SMS

SMS text message content:

`ssss_C1:OFF` or `ssss_out-name:OFF`

Value: `ssss` - 4-digit SMS password; `out-name` - up to 16 characters output name.

Example: `1111_C1:OFF`

Config
Tool

This operation may be carried out from the PC using the *ELDES Configuration Tool* software.

WEB
BROWSER

This operation may be remotely carried out from the PC using the web browser.

Turn ON output
for time period

ONLY FOR ESIM120

SMS

SMS text message content:

`ssss_Co:ON:hr.mn.sc` or `ssss_out-name:ON:hr.mn.sc`

Value: `ssss` - 4-digit SMS password; `o` - output number, range - [1... 2]; `hr` - hours, range - [00... 23]; `mn` - minutes, range - [00... 59]; `sc` - seconds, range - [00... 59]; `out-name` - up to 16 characters output name.

Example: `1111_C2:ON:00.00.09`

Config
Tool

This operation may be carried out from the PC using the *ELDES Configuration Tool* software.

WEB
BROWSER

This operation may be remotely carried out from the PC using the web browser.

Turn OFF output
for time period

ONLY FOR ESIM120

SMS

SMS text message content:

`ssss_Co:OFF:hr.mn.sc` or `ssss_out-name:OFF:hr.mn.sc`

Value: `ssss` - 4-digit SMS password; `o` - output number, range - [1... 2]; `hr` - hours, range - [00... 23]; `mn` - minutes, range - [00... 59]; `sc` - seconds, range - [00... 59]; `out-name` - up to 16 characters output name.

Example: `1111_C1:OFF:00.11.49`

Config
Tool

This operation may be carried out from the PC using the *ELDES Configuration Tool* software.

WEB
BROWSER

This operation may be remotely carried out from the PC using the web browser.

To instantly turn ON/OFF the specified output and set its state to ON/OFF when the system starts-up, please refer to the following configuration methods.

Turn ON output/Set output start-up state as ON

ONLY FOR ESIM120

SMS

SMS text message content:

`ssss_Co:ON` or `ssss_out-name:ON`

Value: `ssss` - 4-digit SMS password; `o` - output number, range - [1... 2]; `out-name` - up to 16 characters output name.

Example: `1111_C1:ON`

Config Tool

This operation may be carried out from the PC using the *ELDES Configuration Tool* software.

WEB BROWSER

This operation may be remotely carried out from the PC using the web browser.

Turn OFF output/Set output start-up state as OFF

ONLY FOR ESIM120

SMS

SMS text message content:

`ssss_Co:OFF` or `ssss_out-name:OFF`

Value: `ssss` - 4-digit SMS password; `o` - output number, range - [1... 2]; `out-name` - up to 16 characters output name.

Example: `1111_C2:OFF`

Config Tool

This operation may be carried out from the PC using the *ELDES Configuration Tool* software.

WEB BROWSER

This operation may be remotely carried out from the PC using the web browser.

NOTE: Output can be turned ON for a determined time period only when it is in OFF state.

NOTE: Output can be turned OFF for a determined time period only when it is in ON state.

NOTE: *ELDES Configuration Tool* software allows to set only the output start-up state.

NOTE FOR ESIM120: The administrator can control any output by SMS text message regardless of the output assigned to the administrator phone number (see **ADMINISTRATOR PHONE NUMBERS**).

11.4. Output Control Confirmation by Call Back

The system can make a phone call confirming that the output control action has been successfully carried out. Once enabled, every output control action will be followed by a 5-second (by default) ring to the user/administrator phone number that the output control by free of charge phone call was initiated from.

By default, output control confirmation by call back is disabled. To enable/disable it, please refer to the following configuration methods.

Enable output control confirmation by call back

SMS

SMS text message content:

`ssss_CALLBACK:ON`

Value: ssss - 4-digit SMS password.

Example: 1111_CALLBACK:ON

Config Tool

This operation may be carried out from the PC using the *ELDES Configuration Tool* software.

WEB BROWSER

This operation may be remotely carried out from the PC using the web browser.

Set call back duration

Config Tool

This operation may be carried out from the PC using the *ELDES Configuration Tool* software.

WEB BROWSER

This operation may be remotely carried out from the PC using the web browser.

Disable output control confirmation by call back

SMS

SMS text message content:

`ssss_CALLBACK:OFF`

Value: ssss - 4-digit SMS password.

Example: 1111_CALLBACK:OFF

Config Tool

This operation may be carried out from the PC using the *ELDES Configuration Tool* software.

WEB BROWSER

This operation may be remotely carried out from the PC using the web browser.

11.5. Output Control from any Phone Number

By default, the system ignores any incoming calls from a non-preset phone number. To permit/deny output control by free of charge phone call (see **11. OUTPUT (-S)**) from a non-preset phone number, please refer to the following configuration methods.

Enable output control from any phone number

SMS

SMS text message content:

`ssss_STR:ON`

Value: ssss - 4-digit SMS password.

Example: 1111_STR:ON

Config Tool

This operation may be carried out from the PC using the *ELDES Configuration Tool* software.

WEB BROWSER

This operation may be remotely carried out from the PC using the web browser.

Disable output control from any phone number

SMS

SMS text message content:

`ssss_STR:OFF`

Value: ssss - 4-digit SMS password.

Example: 1111_STR:OFF

Config Tool

This operation may be carried out from the PC using the *ELDES Configuration Tool* software.

WEB BROWSER

This operation may be remotely carried out from the PC using the web browser.

NOTE: The system will accept SMS text messages only from a preset administrator phone number even if output control from any phone number is enabled.

NOTE FOR ESIM120: Once the output control from any phone number is enabled, a non-preset phone number user will be able to control output C1 only.

11.6. Automatic Output Control

The system comes equipped with automatic output control in accordance with the assigned scheduler (-s). When one or more schedulers are assigned, the output will automatically turn ON/OFF on the specified weekdays and time set up in the scheduler. The system allows to assign up to 8 different schedulers. For more details on how to set up the schedulers, please refer to **12. SCHEDULERS**.

Assign scheduler

ONLY FOR ESIM110

SMS

SMS text message content:

`ssss_OSHED1_c:ON`

Value: ssss - 4-digit SMS password; c - scheduler number; range - [1... 8].

Example: 1111_OSCHED1_8:ON

Config Tool

This operation may be carried out from the PC using the *ELDES Configuration Tool* software.

WEB BROWSER

This operation may be remotely carried out from the PC using the web browser.

Remove scheduler

ONLY FOR ESIM110

SMS

SMS text message content:

`ssss_OSCHED1_c:OFF`

Value: ssss - 4-digit SMS password; c - scheduler number; range - [1... 8].

Example: 1111_OSCHED1_3:OFF

Config Tool

This operation may be carried out from the PC using the *ELDES Configuration Tool* software.

WEB BROWSER

This operation may be remotely carried out from the PC using the web browser.

Assign scheduler

ONLY FOR ESIM120

SMS

SMS text message content:

`ssss_OSCHEDo_c:ON`

Value: ssss - 4-digit SMS password; o - output number, range [1 - output C1; 2 - output C2]; c - scheduler number; range - [1... 8].

Example: 1111_OSCHED2_1:ON

Config Tool

This operation may be carried out from the PC using the *ELDES Configuration Tool* software.

WEB BROWSER

This operation may be remotely carried out from the PC using the web browser.

Remove scheduler

ONLY FOR ESIM120

SMS

SMS text message content:

`ssss_OSCHEDo_c:OFF`

Value: ssss - 4-digit SMS password; o - output number, range [1 - output C1; 2 - output C2]; c - scheduler number; range - [1... 8].

Example: 1111_OSCHED1_5:OFF

Config Tool

This operation may be carried out from the PC using the *ELDES Configuration Tool* software.

WEB BROWSER

This operation may be remotely carried out from the PC using the web browser.

ATTENTION: Once the scheduler, set up for automatic output control, comes into effect, the user/administrator will NOT be able to control the output by phone call and SMS text message.

ATTENTION: If the date and time are not set, the system will NOT be able to manage automatic output control. For more details on how to set date and time, please refer to **9. DATE AND TIME**.

12. SCHEDULERS

The system comes equipped with 8 schedulers that allow to set up the day (-s) of the week and time parameters. The schedulers are used to set up user access restriction (see **10.1. User Validity and Access Restriction**) as well as automatic output control (see **11.6. Automatic Output Control**). Each scheduler includes the following parameters:

- **Every Day** - Determines whether the scheduler will be valid everyday regardless of the current day of the week.
- **At Specified Day (-s)** - Determines day (-s) in the week when the scheduler is to be valid.
- **Start Time** - Determines the point in time when the scheduler is to take effect.
- **End Time** - Determines the point in time when the scheduler is to cease to take effect.

Select At Specified Day (-s)

SMS

SMS text message content:

`ssss_SCHEDc_AL:OFF`

Value: ssss - 4-digit SMS password; c - scheduler number; range - [1... 8].

Example: 1111_SCHED4_AL:OFF

Config Tool

This operation may be carried out from the PC using the *ELDES Configuration Tool* software.

WEB BROWSER

This operation may be remotely carried out from the PC using the web browser.

Enable day (-s) of the week

SMS

SMS text message content:

`ssss_SCHEDc_wd:ON`

Value: ssss - 4-digit SMS password; c - scheduler number; range - [1... 8]; wd - weekday, range - [MO - Monday; TU - Tuesday; WE - Wednesday; TH - Thursday; FR - Friday; SA - Saturday; SU - Sunday].

Example: 1111_SCHED6_FR:ON

Config Tool

This operation may be carried out from the PC using the *ELDES Configuration Tool* software.

WEB BROWSER

This operation may be remotely carried out from the PC using the web browser.

Disable day (-s) of the week

SMS

SMS text message content:

`ssss_SCHEDc_wd:OFF`

Value: ssss - 4-digit SMS password; c - scheduler number; range - [1... 8]; wd - weekday, range - [MO - Monday; TU - Tuesday; WE - Wednesday; TH - Thursday; FR - Friday; SA - Saturday; SU - Sunday].

Example: 1111_SCHED4_SU:OFF

Config Tool

This operation may be carried out from the PC using the *ELDES Configuration Tool* software.

WEB BROWSER

This operation may be remotely carried out from the PC using the web browser.

Set start time

SMS

SMS text message content:

`ssss_SCHEDc_st:hr:mn`

Value: ssss - 4-digit SMS password; c - scheduler number; hr - hours, range - [00...23]; mn - minutes, range - [00...59].

Example: 1111_SCHED2_ST:20:25

Config Tool

This operation may be carried out from the PC using the *ELDES Configuration Tool* software.

WEB BROWSER

This operation may be remotely carried out from the PC using the web browser.

Set end time

SMS

SMS text message content:

`ssss_SCHEDc_en:hr:mn`

Value: ssss - 4-digit SMS password; c - scheduler number; hr - hours, range - [00...23]; mn - minutes, range - [00...59].

Example: 1111_SCHED8_EN:09:12

Config Tool

This operation may be carried out from the PC using the *ELDES Configuration Tool* software.

WEB BROWSER

This operation may be remotely carried out from the PC using the web browser.

Select Every Day

SMS

SMS text message content:

`ssss_SCHEDc_AL:ON`

Value: ssss - 4-digit SMS password; c - scheduler number, range - [1... 8]

Example: 1111_SCHED1_AL:ON

Config Tool

This operation may be carried out from the PC using the *ELDES Configuration Tool* software.

WEB BROWSER

This operation may be remotely carried out from the PC using the web browser.

View individual scheduler parameters

SMS

SMS text message content:

`ssss_SCHEDc?`

Value: ssss - 4-digit SMS password; c - scheduler number, range - [1... 8]

Example: 1111_SCHED3?

NOTE: Multiple scheduler parameters can be configured by a single SMS text message, **Example:** 111_SCHED2__MO:ON_FR:OFF_EN:20:18_TH:OFF_ST:15:25_TU:ON_AL:OFF

ATTENTION: If the date and time are not set, the system will NOT be able to use the schedulers. For more details on how to set date and time, please refer to **9. DATE AND TIME**.

13. EVENT LOG

This feature allows to chronologically register up to 1000 timestamped records regarding the following system events:

- Output control including the user/administrator phone number and user name.
- User validity expiry by deadline.
- User validity expiry by ring counter.
- Automatic output control beginning.
- Automatic output control ending.

To export the event log to .log file or clear it, please refer to the following configuration methods.

Export event log



This operation may be carried out from the PC using the *ELDES Configuration Tool* software.



This operation may be remotely carried out from the PC using the web browser.

By default, when the event log reaches the 1000 record limit, the system will send the notification by SMS text message to the administrator phone number. To clear the event log and/or disable/enable the notification regarding the full event log, please refer to the following configuration methods.

Clear event log



SMS text message content:

`ssss_DELETELOG`

Value: ssss - 4-digit SMS password.

Example: 1111_DELETELOG



This operation may be carried out from the PC using the *ELDES Configuration Tool* software.



This operation may be remotely carried out from the PC using the web browser.

Disable Log Full notification



This operation may be carried out from the PC using the *ELDES Configuration Tool* software.



This operation may be remotely carried out from the PC using the web browser.

Enable Log Full notification



This operation may be carried out from the PC using the *ELDES Configuration Tool* software.



This operation may be remotely carried out from the PC using the web browser.

The event log may be set as of LIFO (last in, first out) type that allows the system to automatically replace the oldest records with the the latest ones. By default, LIFO type event log is disabled. To enable/disable it, please refer to the following configuration methods.

Enable LIFO type log



This operation may be carried out from the PC using the *ELDES Configuration Tool* software.



This operation may be remotely carried out from the PC using the web browser.

Disable LIFO type log



This operation may be carried out from the PC using the *ELDES Configuration Tool* software.



This operation may be remotely carried out from the PC using the web browser.

14. INPUTS

The system comes equipped with 3 inputs designed for fault indication output or detection device connection, such as door contacts. Once a fault indication output and/or a detection device is triggered, the system will send a notification to the administrator phone number. Typically, the inputs are used to receive notifications regarding jammed gate or gate state. For more details, please refer to **14.1. Input Names and Alarm Notifications**.

Each input's sensitivity level can be customized by a delay time (by default - 600 milliseconds). If an input is left triggered until the delay time expires, the input is considered violated.

Set input delay

SMS

SMS text message content:

`ssss_Tn:in-delay`

Value: ssss - 4-digit SMS password; n - input number, range - [1... 3]; in-delay - input delay, range - [100... 42000000] milliseconds.

Example: 1111_T3:10500

Config
Tool

This operation may be carried out from the PC using the *ELDES Configuration Tool* software.

WEB
BROWSER

This operation may be remotely carried out from the PC using the web browser.

The system allows to view the current input state by the following configuration method.

View input state

SMS

SMS text message content:

`ssss_INFO`

Value: ssss - 4-digit SMS password;

Example: 1111_INFO

14.1. Input Names and Alarm Notifications

Each input has a name that can be customized. Typically, the name specifies a device type connected to a certain input terminal, for example: *GateOpen*. The input names are used in notifications that are sent by SMS text message to the administrator regarding the input alarm event. By default, the input names are: Z1 - zone1, Z2 - zone2, Z3 - zone3.

Set input name

SMS

SMS text message content:

`ssss_Zn:input-name`

Value: ssss - 4-digit SMS password; n - input number, range - [1... 3]; input-name - up to 8 characters input name.

Example: 1111_Z2:GateOpen

Config
Tool

This operation may be carried out from the PC using the *ELDES Configuration Tool* software.

WEB
BROWSER

This operation may be remotely carried out from the PC using the web browser.

View input names

SMS

SMS text message content:

`ssss_STATUS`

Value: ssss - 4-digit SMS password.

Example: 1111_STATUS

Config Tool

This operation may be carried out from the PC using the *ELDES Configuration Tool* software.

WEB BROWSER

This operation may be remotely carried out from the PC using the web browser.

By default, the system sends SMS text message to the first available administrator in case of input alarm. If the system did not receive the SMS delivery report during 20 seconds, it will attempt to send the SMS text message to the next preset administrator phone number. To ignore the SMS delivery report and allow/disallow the system to send the SMS text message to every preset administrator phone number, please refer to the following configuration methods.

Enable notification to all preset administrator phone numbers in case of input alarm

SMS

SMS text message content:

`ssss_SMSALL:ON`

Value: ssss - 4-digit SMS password.

Example: 1111_SMSALL:ON

Config Tool

This operation may be carried out from the PC using the *ELDES Configuration Tool* software.

WEB BROWSER

This operation may be remotely carried out from the PC using the web browser.

Disable notification to all preset administrator phone numbers in case of input alarm

SMS

SMS text message content:

`ssss_SMSALL:OFF`

Value: ssss - 4-digit SMS password.

Example: 1111_SMSALL:OFF

Config Tool

This operation may be carried out from the PC using the *ELDES Configuration Tool* software.

WEB BROWSER

This operation may be remotely carried out from the PC using the web browser.

ATTENTION: Space characters, parameter values, such as ON, OFF etc. are NOT allowed in the input names. Space characters, parameter values, such as ON, OFF etc. are NOT allowed in the input names.

For more details on how to disable the input alarm notifications, please refer to **14.2. Disabling and Enabling Inputs**.

For more details on the algorithm of how the system sends the notifications, please refer to **16. SYSTEM NOTIFICATIONS**.

14.2. Disabling and Enabling Inputs

By default, all inputs are enabled. Once disabled, input alarm event will no longer be followed by an SMS text message. To disable/enable an individual input, please refer to the following configuration methods.

Disable input

SMS

SMS text message content:

`ssss_Zn:OFF`

Value: `ssss` - 4-digit SMS password; `n` - input number, range - [1... 3]; `input-name` - up to 8 characters input name.

Example: `1111_Z2:Gate jammed`

Config Tool

This operation may be carried out from the PC using the *ELDES Configuration Tool* software.

WEB BROWSER

This operation may be remotely carried out from the PC using the web browser.

Enable input

SMS

SMS text message content:

`ssss_Zn:ON`

Value: `ssss` - 4-digit SMS password; `n` - input number, range - [1... 3]; `input-name` - up to 8 characters input name.

Example: `1111_Z2:Gate jammed`

Config Tool

This operation may be carried out from the PC using the *ELDES Configuration Tool* software.

WEB BROWSER

This operation may be remotely carried out from the PC using the web browser.

View input status

SMS

SMS text message content:

`ssss_STATUS`

Value: `ssss` - 4-digit SMS password.

Example: `1111_STATUS`

Config Tool

This operation may be carried out from the PC using the *ELDES Configuration Tool* software.

WEB BROWSER

This operation may be remotely carried out from the PC using the web browser.

15. SYSTEM INFORMATION. INFO SMS

The system supports an informational SMS text message identified as the Info SMS, which can be delivered upon request. Once requested, the system will reply with Info SMS that provides the following:

- System date & time.
- GSM signal strength.
- Number of occupied and empty slots in the user database.
- State of inputs (OK/alarm).

Request for system information

SMS

SMS text message content:

`ssss_INFO`

Value: ssss - 4-digit SMS password.

Example: 1111_INFO

Config Tool

This operation may be carried out from the PC using the *ELDES Configuration Tool* software.

WEB BROWSER

This operation may be remotely carried out from the PC using the web browser.

For more details on the algorithm of how the system sends the notifications, please refer to **16. SYSTEM NOTIFICATIONS**.

15.1. Periodic Info SMS

The system may send the Info SMS to the administrator phone number periodically. The recommended period is once a day at 11:00 (frequency - 1 day; time - 11). The minimum period is every 1 hour (frequency - 0 days; time - 1). Typically, this feature is used to verify the operation status of the system.

To enable periodic Info SMS by setting the frequency and time or disable it, please refer to the following configuration methods.

Set periodic Info SMS frequency and time

SMS

SMS text message content:

`ssss_INFO:fff:it`

Value: ssss - 4-digit SMS password; *fff* - frequency, range - [00... 99] days; *it* - time, range - [01... 23].

Example: 1111_INFO:3.15

Config Tool

This operation may be carried out from the PC using the *ELDES Configuration Tool* software.

WEB BROWSER

This operation may be remotely carried out from the PC using the web browser.

Disable periodic Info SMS

SMS

SMS text message content:

`ssss_INFO:00:00`

Value: ssss - 4-digit SMS password.

Example: 1111_INFO:00.00

Config Tool

This operation may be carried out from the PC using the *ELDES Configuration Tool* software.

WEB BROWSER

This operation may be remotely carried out from the PC using the web browser.

16. SYSTEM NOTIFICATIONS

In case of a certain event, the system attempts to send an SMS text message to the first preset administrator phone number only. If the administrator phone number is unavailable and the system fails to receive the SMS delivery report within 20 seconds, it will attempt to send the SMS text message to the next preset administrator phone number. The administrator phone number may be unavailable due to the following reasons:

- mobile phone was switched off.
- was out of GSM signal coverage.

The system will continue sending the SMS text message to the next preset administrator phone numbers in the priority order until one is available. The system sends the SMS text message only once and will not return to the first administrator phone number if the last one was unavailable.

16.1. SMSC (Short Message Service Center) Phone Number

An SMS center (SMSC) is a GSM network element, which routes SMS text messages to the destination recipient and stores the SMS text message if the recipient is unavailable. Typically, the phone number of the SMS center is already stored in the SIM card provided by the GSM operator. If the administrator fails to receive replies from the system, the SMS center phone number, provided by the GSM operator, must be set manually.

Set SMSC phone number

SMS

SMS text message content:

`ssss_SMS_+ttteeeellnnuumm`

Value: `ssss` - 4-digit SMS password; `ttteeeellnnuumm` - up to 15 digits SMSC phone number.

Example: `1111_SMS_+4417031111111`

ATTENTION: Before setting the SMSC phone number, please check the credit balance of the system's SIM card. The system will fail to reply if the credit balance is insufficient.

17. GPRS NETWORK SETTINGS

The GPRS network settings are used for device communication with the remote configuration server or Smart Gate server via GPRS connection. To set the GPRS network settings, please refer to the following configuration methods.

Set APN

SMS

SMS text message content:

`ssss_SETGPRS:APN:acc-point-name`

Value: ssss - 4-digit SMS password; *acc-point-name* - up to 31 character APN (Access Point Name) provided by the GSM operator.

Example: `1111_SETGPRS:APN:internet`

Config Tool

This operation may be carried out from the PC using the *ELDES Configuration Tool* software.

WEB BROWSER

This operation may be remotely carried out from the PC using the web browser.

Set user name

SMS

SMS text message content:

`ssss_SETGPRS:USER:usr-name`

Value: ssss - 4-digit SMS password; *usr-name* - up to 31 character user name provided by the GSM operator.

Example: `1111_USER:mobileusr`

Config Tool

This operation may be carried out from the PC using the *ELDES Configuration Tool* software.

WEB BROWSER

This operation may be remotely carried out from the PC using the web browser.

Set password

SMS

SMS text message content:

`ssss_SETGPRS:PSW:password`

Value: ssss - 4-digit SMS password; *password* - up to 31 character password provided by the GSM operator.

Example: `1111_SETGPRS:PSW:mobilepsw`

Config Tool

This operation may be carried out from the PC using the *ELDES Configuration Tool* software.

WEB BROWSER

This operation may be remotely carried out from the PC using the web browser.

View GPRS network settings

SMS

SMS text message content:

`ssss_SETGPRS?`

Value: ssss - 4-digit SMS password.

Example: `1111_SETGPRS?`

Config Tool

This operation may be carried out from the PC using the *ELDES Configuration Tool* software.

WEB BROWSER

This operation may be remotely carried out from the PC using the web browser.

NOTE: Multiple parameters can be set by single SMS text message, **Example:** `1111_SETGPRS:APN:internet;USER:mobileusr;PSW:mobilepsw`

18. REMOTE SYSTEM RESTART

In some critical situations, a system restart may be required. To remotely carry out system restart, please refer to the following configuration method.

Restart the system

SMS

SMS text message content:

`ssss_RESTART`

Value: ssss - 4-digit SMS password.

Example: `1111_RESTART`

19. TECHNICAL SUPPORT

19.1. Troubleshooting

Indication	Possible reason
Indicators SIM STAT and NETW are OFF	<ul style="list-style-type: none">· No mains power· Wrong wiring· Blown fuse· Disconnected antenna· Micro-controller could not start due to electrical mains noise or static discharge
Indicator SIM STAT is ON	<ul style="list-style-type: none">· Missing SIM card· PIN code is enabled· SIM card is inactive· GSM network fault
Unable to receive any SMS text messages to the administrator phone number or control the output	<ul style="list-style-type: none">· Insufficient SIM card credit balance· Caller's phone number is set up as withheld (hidden)· No GSM network signal· Wrong administrator/user phone number· Administrator/user phone number is not set· SIM card was replaced before disconnecting mains power· Incorrect SMS center phone number
Unable to connect to the device remotely via GPRS connection	<ul style="list-style-type: none">· GPRS settings (APN, user name, password) not set.· Insufficient SIM card credit balance· Mobile internet service (GPRS) not activated on the SIM card.
Received SMS text message "Wrong syntax"	<ul style="list-style-type: none">· Incorrect SMS text message structure· Unnecessary space character might have been typed in SMS text message

For product warranty repair service please, contact your local retail store where this product was purchased.

If your problem could not be fixed by the self-guide above, please contact your local distributor. More up to date information about your device and other products can be found at the manufacturer's website www.eldes.it

19.2. Restoring Default Parameters

1. Power down the device.
2. Short-circuit (connect) the DEF pins.
3. Power up the device for 7 seconds.
4. Power down the device.
5. Remove the short-circuit from DEF pins.
6. Parameters restored to default.

19.3. Updating the Firmware via USB Cable

1. Power down the device.
2. Short-circuit (connect) the DEF pins.
3. Connect the device via USB cable to the PC.
4. Power up the device.
5. The new window must pop-up where you will find the .bin file. Otherwise open *My Computer* and look for *Boot Disk* drive.
6. Delete the .bin file found in the drive.
7. Copy the new firmware .bin file to the very same window.
8. Power down the device.
9. Unplug the USB cable.
10. Remove the short-circuit from DEF pins.
11. Power up the device.
12. Firmware updated.

NOTE: It is strongly recommended to restore default parameters after the firmware update.

20. RELATED PRODUCTS

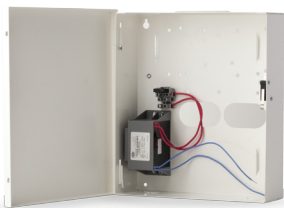

ME1 - metal cabinet



EBU1 - power backup unit



Power supply



IP66 - plastic enclosure

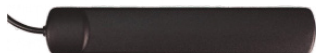

Adhesive flat GSM antenna



Magnet mount straight GSM antenna

Copyright © "ELDES UAB", 2013. All rights reserved

It is not allowed to copy and distribute information in this document or pass to a third party without advanced written authorization by "ELDES UAB". "ELDES UAB" reserves the right to update or modify this document and/or related products without a warning. Hereby, "ELDES UAB" declares that GSM switch-gate controller ESIM110/ESIM120 is in compliance with the essential requirements and other relevant provisions of Directive 1999/5/EC. The declaration of conformity may be consulted at www.eldes.it



Made in the European Union
www.eldes.it